

DH-PFS4218-16ET-240

16-port 100 Mbps + 2-port Gigabit Managed PoE Switch



- Intelligent PoE
- Red port supports 90W IEEE802.3bt
- Web management with friendly interface and easy operation
- 250 m long distance PoE transmission
- PoE watchdog
- Plug and play



System Overview

DH-PFS4218-16ET-240 is a type of layer-two managed PoE switch. It provides 16 100 Mbps PoE ports and 2 gigabit uplink combo ports. The full load is 240W.

With all metal design, the product has good heat dissipation and low power consumption, which can work in environments from -10°C to $+55^{\circ}\text{C}$.

The product owns powerful network management functions. Network management system supports CLI, iLinksView, web and network management software based on SNMP.

Functions

Uplink Combo Port

Two of the uplink ports support a self-adaptive 10/100/1000 Mbps RJ-45 port or a 1000 Mbps optical port.

Intelligent PoE

The switch features intelligent PoE power consumption management to help keep the power and data flowing, even when the switch experiences a power fault. Intelligent PoE monitors the power consumption of the connected devices, and in the event of large power fluctuations, the switch shuts down one port at a time rather than shutting down all ports. Unlike typical switches that shut down all ports as once, this switch shuts down the highest number port first, then the next highest number until the switch detects the power consumption is below the PoE budget. Green PoE can power on and power off according to time strategy. It can also realize PoE legacy support.

BT 90W

The red port supports the IEEE802.3bt and the Hi-PoE standards. The maximum power consumption is 90W.

PoE Watchdog

The switch employs an innovative PoE watchdog function that automatically detects a network port failure and restarts network communication on the port. This functionality avoids manual maintenance and network restarts, saving time and reducing costs.

Long Distance PoE

Long-distance PoE transmission extends the maximum transmission distance to 250 m (from 100 m), but reduces transmission speed to a maximum of 10 Mbps (from 1000 Mbps).

Various Operating Environments

The switch is designed to operate in severe environments and in temperatures ranging from -10°C to $+55^{\circ}\text{C}$ (14°F to 131°F). The switch includes a professional-grade surge protection circuit that offers 4 kV (common mode) and 2 kV (differential mode) all-port lightning protection. This protection reduces damage to the network from a lightning storm. The switch meets the Class B EMC standard and is suitable for residential, commercial, and light-industrial applications.

Scene

Applicable to small and micro-scale monitoring networks such as office desktops, schools, hotels, supermarkets and hospitals.

Technical Specification

Performance

Layer	Layer 2
Managed	Yes
Switching Capacity	8.8 Gbps
Packet Forwarding Rate	5.36 Mpps
Packet Buffer Memory	2.75 Mbit
MAC Table Size	4K
Communication Standard	IEEE802.3; IEEE802.3u; IEEE802.3x; IEEE 802.3ab; IEEE 802.3z

Hardware Feature

Standard Power Supply	Yes
PoE	Yes
Ethernet Port	16
Optical Port	2
Ethernet Port Rate	100 Mbps
Optical Port Rate	1 Gbps
Number of Business Card Slots	Port 1-16: 16 × RJ-45 10 M/100 M (PoE) Port 17-18: 2 × RJ-45 10 M/100 M/1000 M (uplink) Port 17-18: 2 × SFP 1000 M (uplink) (combo)
Debugging	Console × 1
Power Supply	100V–240V AC
Operating Temperature	–10 °C to +55 ° (14 °F to 131 °F)
Operating Humidity	10% RH–90% RH
Power Consumption	Idling: 10W Full load: 240W

PoE

PoE Standard	IEEE802.3af/ IEEE802.3at/ Hi-PoE/IEEE802.3bt
PoE Budget	Port 1-2 ≤ 90W, Port 3-16 ≤ 30W, total ≤ 240W
PoE Pin Assignment	1, 2, 4, 5 (V+), 3, 6, 7, 8 (V-)
PoE Management	Power consumption management Power on and power off Power down for overload Green PoE Legacy support
Long Distance PoE Transmission	250 m long-distance power supply

Function

Spanning Tree Protocol	IEEE 802.1d (STP); 802.1w (RSTP)
VLAN	IEEE802.1q Standard VLAN
Flow Control	Support IEEE 802.3x (full duplex flow control) and back pressure flow control (half duplex)
Link Aggregation	Static; LACP
Port Mirroring	One-to-one; multiple-to-one

Multicast	GMP snooping based on port
DHCP	DHCP client
Security	Hardware supports IP and MAC binding based on port, MAC filtering based on port, and IEEE802.1x port authentication
QoS	High and low priority WRR 802.1P DSCP Priority based on protocol

General

ESD	Air discharge: 8kV Contact discharge: 6kV
Thunder-proof	Common mode: 4kV Differential mode: 2kV
Dimensions	440 mm × 300 mm × 44 mm (17.32" × 11.81" × 1.73") (L × W × H)
Packaging Dimensions	Packing box: 527 mm × 412 mm × 110 mm (20.75" × 16.22" × 4.33") (L × W × H) Protective box: 584 mm × 549 mm × 446 mm (22.99" × 21.61" × 17.56") (L × W × H)

Installation

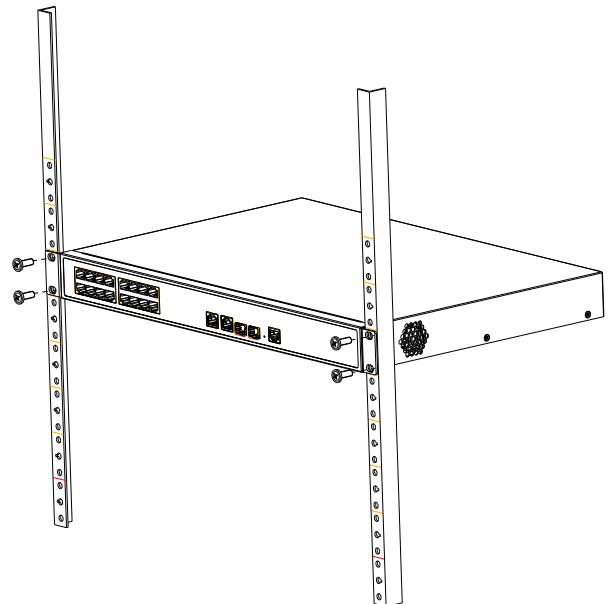

Dimensions (mm[inch])

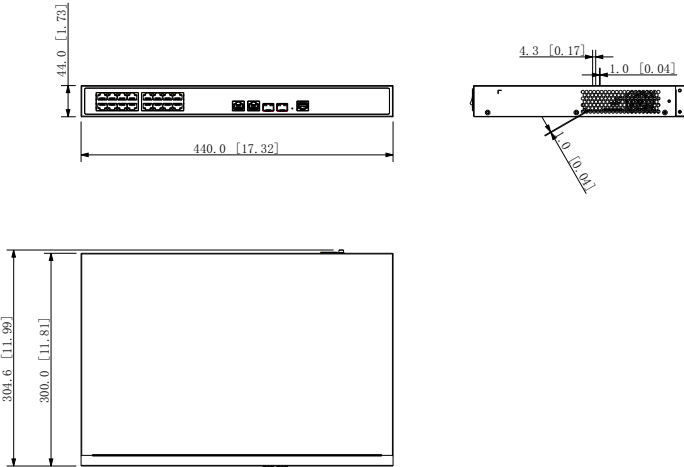

Application

